

Article number: 2314452797

Description: E+G polyurethane wheel 452797  
RE.G5-82x70-RSL - Loose wheel with ball bearings

## Measures

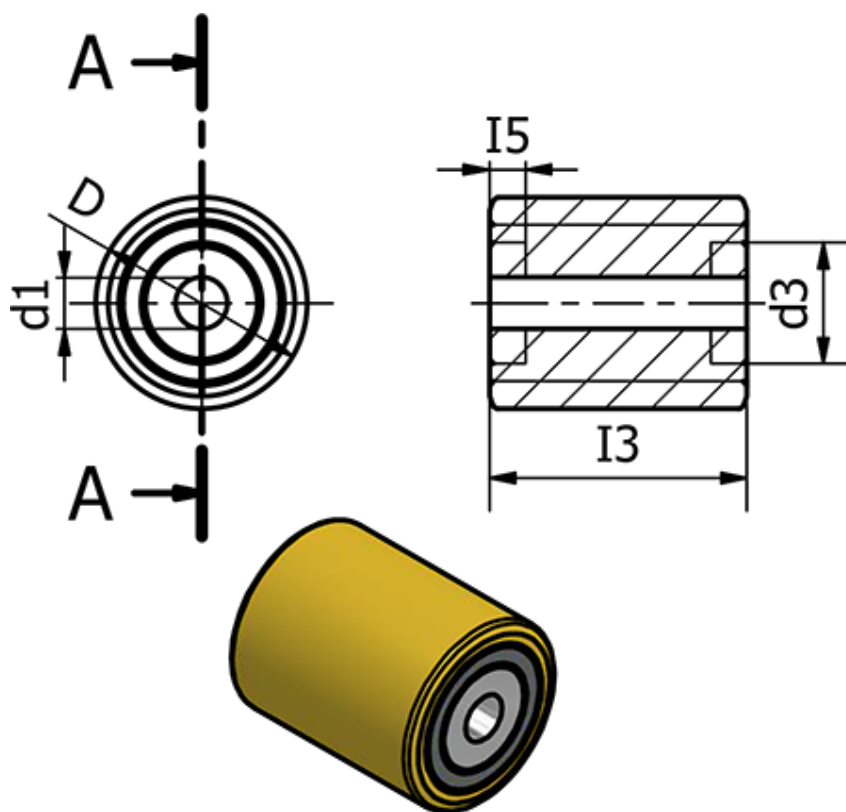

Code	= 452797	Static load (N)	= 8000
D	= 82	Type	= RE.G5-82x70-RSL
d1	= 20	Weight (g)	= 1090
d3	= 47		
Dynamic carrying capacity (N)	= 7000		
I3	= 70		
I5	= 14		
Rolling resistance (N)	= 2550		